

RF UNIT K200



TURN KEY RF UNIT 35 MW/20 kW

ScandiNova's K200 is a turn-key Radio Frequency (RF) Unit. By combining ScandiNova's solid-state pulsed power technology with high quality klystrons from well-known manufacturers, a very compact, high performance RF Unit has been created, providing up to 35 MW RF peak power. The RF Unit is optimized for a wide range of klystrons from Canon, CPI, Thales, Stellant, and others.

The K200 is fully equipped with Klystron, Solenoid, klystron accessories and supporting systems, such as Solenoid Power Supply, Ion Pump Power Supply, RF Amplifier, internal cooling system and radiation shielding. All interlocks and essential diagnostics are fully integrated, and the ScandiCAT™ control system offers a safe and easy-to-use means of controlling the RF Unit.

There are several alternatives and options available for the RF Unit, e.g. different interfaces and RF components as well as different levels of service and support programmes.

COMPACT

FULLY EQUIPPED

UP TO 35 MW RF PEAK POWER

FOR USE IN VARIOUS RF APPLICATIONS

INTEGRATED WITH KLYSTRON

THE K-SERIES

ScandiNova's K-series contains a range of klystron based RF units with high reliability and performance, a compact design and low energy consumption.

The RF units utilize ScandiNova's unique solid-state pulsed power technology, integrated with different types of klystrons, usually operating in the RF peak power range 3-100 MW.

The RF units have extended diagnostics and features, and are easy to install and operate. They contain few consumables and require minimal maintenance.

SYSTEM SPECIFICATIONS	UNIT	VALUE*	NOTES
Klystron RF peak power	MW	7-35	Depends on choice of klystron
Klystron RF average power	kW	20	Maximum
RF frequency	GHz	1.3-12	L, S, C or X-band depending on klystron
RF pulse length, top	µs	0.5-10	Typical range, depends on max modulator power
Pulse repetition rate	Hz	0-500	Typical range, depends on max average power
Voltage pulse to pulse stability	ppm	< 50	RMS 1000 consecutive pulses at operating pulse repetition rate
RF pulse flatness	%	< ±1.0	Flat top, depends on klystron
Radiation at 1 m distance	µSv/h	< 10	Depends on type of klystron

* All maximum values cannot be reached simultaneously.

INTERFACE	CONNECTOR	DEFAULT	OPTION	NOTES
Mains power, three-phase	Terminal block (4-wire)	400 VAC, 50/60 Hz	208/380/480 VAC	
Mains power, single-phase	Terminal block	230 VAC, 50/60 Hz	115 VAC	
Control interface	RJ45	Modbus TCP		100 Hz update rate
Water cooling interface	BSPP G2", 1-2" hose barb	20-30 °C inlet water	31-40 °C inlet water	Low conductivity water
Trig input	BNC	5-15 V into 50 Ω	HFBR: Optical	Pulse width can be set by trig pulse
Diagnostics	BNC	Pulse voltage & current signals		More diagnostics available via control system
RF amplifier input	SMA	Nominal input power 0 dBm		Max +15 dBm

SIZE, WEIGHT AND VOLUME	UNIT	VALUE
Total system weight*	kg	2340
- Modulator	kg	1400
- Klystron, Solenoid and oil*	kg	940
Total oil volume	dm ³	380

* Weights can vary depending on Klystron and Solenoid.

For more information, visit www.scandinovasystems.com/K200

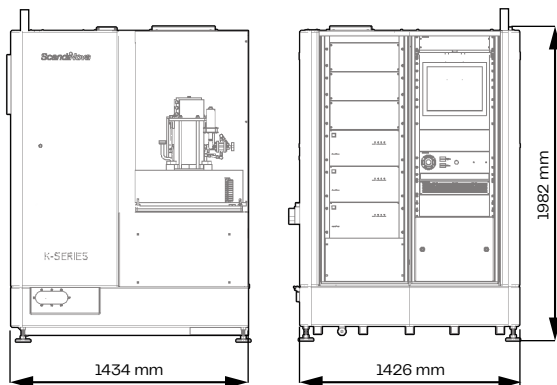

Information contained in this document is subject to change without notice.

The Standard RF Unit Includes

- Power Distribution Unit
- Capacitive Charging Power Supply
- Solid-state Switch Unit
- Pulse transformer and tank
- Water cooling manifold and flow meters diagnostics
- Oil moisture and temperature sensor
- Filament power supply
- Local control panel (19" touch screen)
- Graphical user interface
- ScandiCAT™ control system
- Digitizer for modulator diagnostics
- Remote control via Modbus TCP
- Klystron
- Solenoid
- Solenoid Power Supply
- Ion Pump Power Supply
- Factory acceptance test certificate
- Manuals

Options

- RF Digitizer (FWD/RFL power/VSWR)
- Directional coupler
- RF Amplifier
- Internal controllable RF source
- Internal controllable phase shifter
- Neutron resistant Switch Unit
- Signal delay generator
- Additional radiation shielding
- Control rack on left side (mirrored)
- Klystron conditioning tool
- Reduced filament heating mode
- Seismic reinforcement kit

Accessories

- Circulator & RF loads
- Waveguides
- Waveguide window
- SF6 filling kit
- Vacuum parts
- Spare part kit

Services

- Training in handling, operation and maintenance
- Factory acceptance test participation
- Site acceptance test
- Shipping
- Installation and start-up
- Service contract

COMPANY WITH
MANAGEMENT SYSTEM
CERTIFIED BY DNV
ISO 9001 • ISO 14001

HEADQUARTERS

ScandiNova Systems AB
Typsnittsgatan 15
SE-754 54 Uppsala, Sweden

CONTACT

Tel: +46 (0)18 480 59 00
E-mail: info@scandinovasystems.com
www.scandinovasystems.com

ScandiNova
Excellence in pulsed power